

## Transient Voltage Suppressors (TVS) Data Sheet

### Features

- Glass passivated junction
- Low incremental surge resistance
- Excellent clamping capability
- 15000W peak pulse power capability at 10/1000 $\mu$ s waveform, repetition rate (duty cycle): 0.05%
- Fast response time
- Typical  $I_R$  less than 2 $\mu$ A above 30V.
- High Temperature soldering guaranteed: 265 $^{\circ}$ C/10 seconds/.375", (9.5mm) lead length, 5lbs (2.3kg) tension
- Plastic package has underwriters laboratory flammability 94V-0
- Meets MSL level 1, per J-STD-020.
- Safety certification: UL: E244458



### Mechanical Data

- Case: Moulded plastic over glass passivated junction
- Terminal: Plated Axial leads, solderable per MIL-STD-750, Method 2026
- Polarity: Color band denotes cathode except bi-directional models
- Mounting Position: Any
- Weight: 2.30g

### Applications

- I/O interface
- AC/DC power supply
- Low frequency signal transmission line (RS232, RS485, etc.)

### Maximum Ratings and Characteristics

Ratings at 25 $^{\circ}$ C ambient temperature unless otherwise specified.

Rating	Symbol	Value	Units
Peak pulse power dissipation at 10/1000 $\mu$ s waveform (Note1, Fig.1)	$P_{PPM}$	Minimum 15000	Watts
Peak pulse current of at 10/1000 $\mu$ s waveform (Note 1, Fig.3)	$I_{PPM}$	See Table	Amps
Steady state power dissipation at $T_L=75^{\circ}$ C (Fig.5)	$P_{M(AV)}$	8.0	Watts
Peak forward surge current, 8.3ms single half sine-wave superimposed on rated load, (JEDEC Method) (Note2, Fig.6)	$I_{FSM}$	400	Amps
Operating junction and Storage Temperature Range.	$T_J, T_{STG}$	-55 to +175	$^{\circ}$ C
Typical thermal resistance junction to lead	$R_{\theta JL}$	8	$^{\circ}$ C/W
Typical thermal resistance junction to ambient	$R_{\theta JA}$	40	$^{\circ}$ C/W

Notes: 1. Non-repetitive current pulse, per Fig.3 and derated above  $T_A=25^{\circ}$ C per Fig.2.

2. 8.3ms single half sine-wave, or equivalent square wave, duty cycle=4 pulses per minutes maximum.

**Dimensions (P600)**

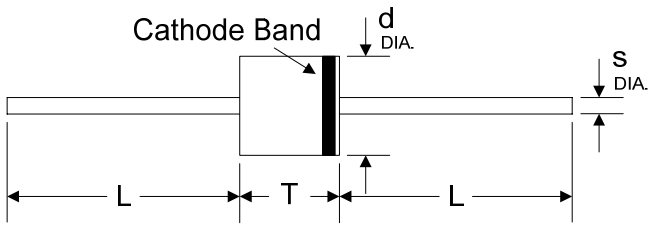
	Symbol	Millimeters		Inches	
		Min.	Max.	Min.	Max.
	L	25.40	-	1.000	-
	T	8.60	9.10	0.340	0.360
	d	8.60	9.10	0.340	0.360
s	1.19	1.32	0.047	0.052	

**Electrical Characteristics ( $T_A=25^\circ\text{C}$ )**

Part Number		Reverse Stand-Off Voltage	Breakdown Voltage @ $I_T$	Test Current	Maximum Clamping Voltage @ $I_{PP}$	Peak Pulse Current	Reverse Leakage @ $V_{RWM}$
Unidirectional	Bidirectional	$V_{RWM}(V)$	$V_{BR}(V)$	$I_T(mA)$	$V_C(V)$	$I_{PP}(A)$	$I_R(\mu A)$
15KPA17A	15KPA17CA	17.0	18.99~21.22	50	29.3	515.4	5000
15KPA18A	15KPA18CA	18.0	20.11~22.65	50	30.9	488.7	5000
15KPA20A	15KPA20CA	20.0	22.34~24.96	20	34.3	440.2	1500
15KPA22A	15KPA22CA	22.0	24.57~27.46	10	37.1	407.0	500
15KPA24A	15KPA24CA	24.0	26.81~29.95	5	40.7	371.0	150
15KPA26A	15KPA26CA	26.0	29.04~32.45	5	44.0	343.2	50
15KPA28A	15KPA28CA	28.0	31.28~34.95	5	47.5	317.9	25
15KPA30A	15KPA30CA	30.0	33.51~37.44	5	50.7	297.8	15
15KPA33A	15KPA33CA	33.0	36.90~41.19	5	54.7	276.1	2
15KPA36A	15KPA36CA	36.0	40.20~44.93	5	59.8	252.5	2
15KPA40A	15KPA40CA	40.0	44.70~49.92	5	65.8	229.5	2
15KPA43A	15KPA43CA	43.0	48.00~53.67	5	69.8	216.3	2
15KPA45A	15KPA45CA	45.0	50.30~56.16	5	72.8	207.4	2
15KPA48A	15KPA48CA	48.0	53.60~59.91	5	77.7	194.3	2
15KPA51A	15KPA51CA	51.0	57.00~63.65	5	82.9	182.1	2
15KPA54A	15KPA54CA	54.0	60.30~67.39	5	87.7	172.2	2
15KPA58A	15KPA58CA	58.0	64.80~72.39	5	93.8	161.0	2

**Electrical Characteristics ( $T_A=25^{\circ}\text{C}$ )**

Part Number		Reverse Stand-Off Voltage	Breakdown Voltage @ $I_T$	Test Current	Maximum Clamping Voltage @ $I_{PP}$	Peak Pulse Current	Reverse Leakage @ $V_{RWM}$
Unidirectional	Bidirectional	$V_{RWM}(V)$	$V_{BR}(V)$	$I_T(mA)$	$V_C(V)$	$I_{PP}(A)$	$I_R(\mu A)$
15KPA60A	15KPA60CA	60.0	67.00~74.88	5	97.4	155.0	2
15KPA64A	15KPA64CA	64.0	71.50~79.87	5	104.2	144.9	2
15KPA70A	15KPA70CA	70.0	78.20~87.36	5	113.6	132.9	2
15KPA75A	15KPA75CA	75.0	83.80~93.60	5	122.0	123.8	2
15KPA78A	15KPA78CA	78.0	87.10~97.35	5	126.1	119.7	2
15KPA85A	15KPA85CA	85.0	94.90~106.08	5	137.6	109.7	2
15KPA90A	15KPA90CA	90.0	100.50~112.32	5	145.6	103.7	2
15KPA100A	15KPA100CA	100.0	111.70~124.80	5	161.3	93.6	2
15KPA110A	15KPA110CA	110.0	122.90~137.28	5	178.6	84.5	2
15KPA120A	15KPA120CA	120.0	134.00~149.76	5	192.3	78.5	2
15KPA130A	15KPA130CA	130.0	145.20~162.25	5	208.3	72.5	2
15KPA150A	15KPA150CA	150.0	167.60~187.21	5	241.9	62.4	2
15KPA160A	15KPA160CA	160.0	178.70~199.69	5	258.6	58.4	2
15KPA170A	15KPA170CA	170.0	189.90~212.17	5	272.7	55.4	2
15KPA180A	15KPA180CA	180.0	201.10~224.65	5	288.5	52.3	2
15KPA200A	15KPA200CA	200.0	223.40~249.61	5	319.1	47.3	2
15KPA220A	15KPA220CA	220.0	245.70~274.57	5	352.5	42.8	2
15KPA240A	15KPA240CA	240.0	268.10~299.53	5	384.6	39.3	2
15KPA260A	15KPA260CA	260.0	290.40~324.49	5	416.7	36.2	2
15KPA280A	15KPA280CA	280.0	312.80~349.45	5	454.5	33.2	2

Notes: For bidirectional type having  $V_{RWM}$  of 30V and less, the  $I_R$  limit is double.

**Ratings and Characteristic Curves ( $T_A=25^\circ\text{C}$  unless otherwise noted)**

**Figure 1. Peak Pulse Power Rating Curve**

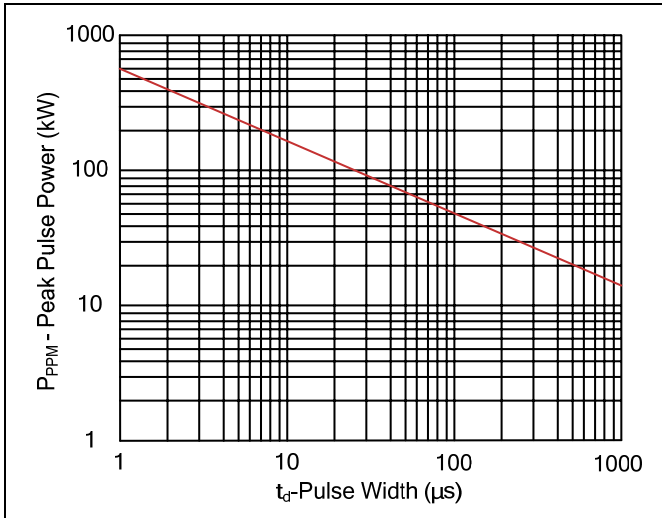

**Figure 2. Pulse Derating Curve**

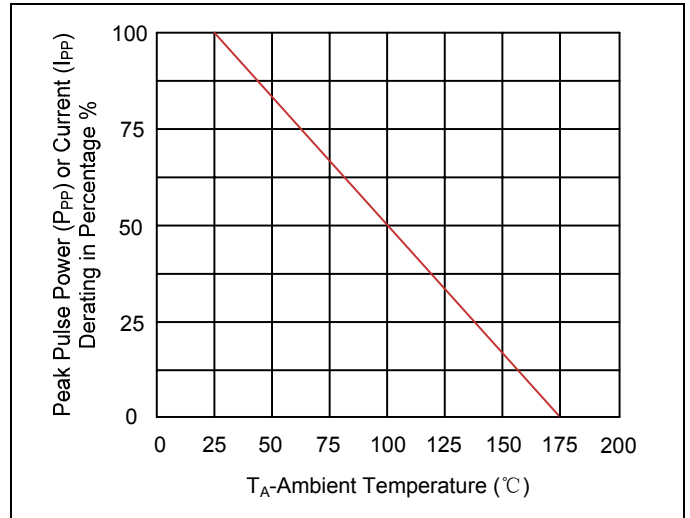

**Figure 3. Pulse Waveform**

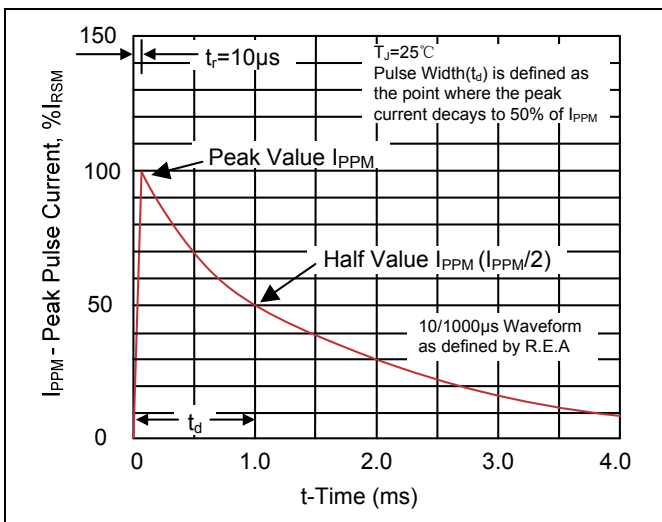

**Figure 4. Typical Junction Capacitance**

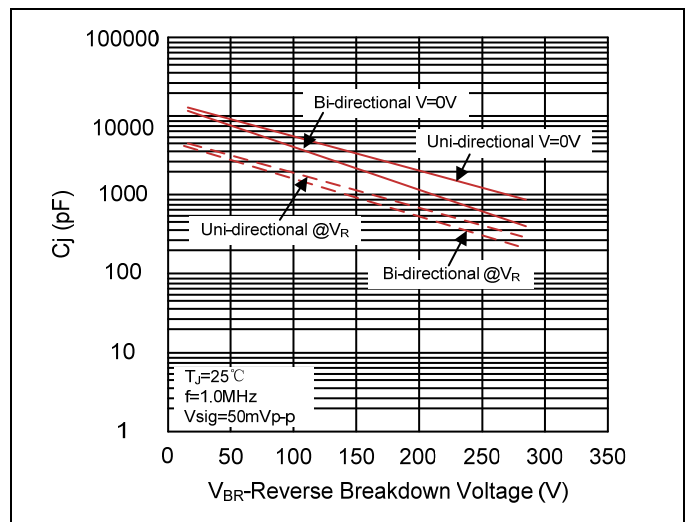

**Figure 5. Steady State Power Dissipation Derating Curve**

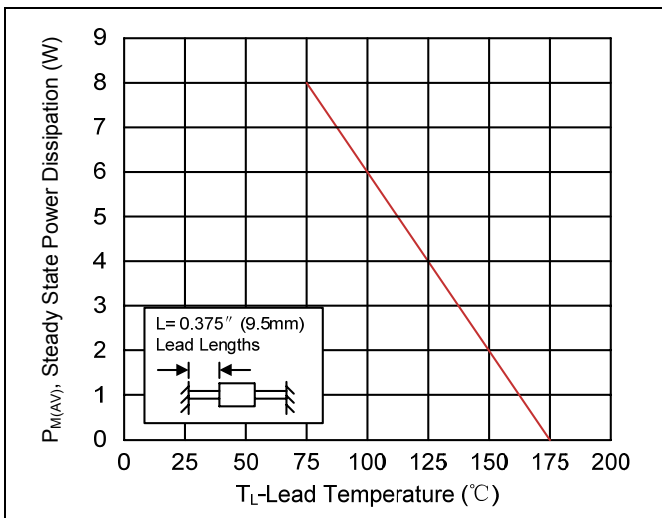

**Figure 6. Maximum Non-Repetitive Forward Surge Current Uni-Directional Only**

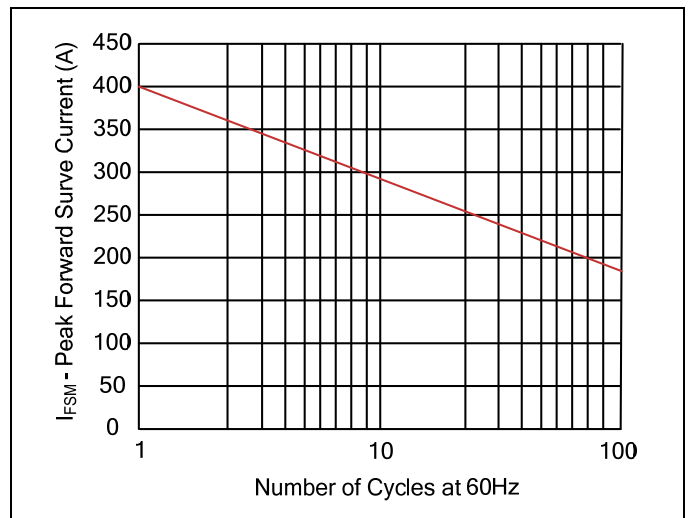

**Recommended Soldering Conditions**

Wave Soldering



Item	Conditions
Peak Temperature	265°C
Dipping Time	10 seconds
Soldering	1 time

**Marking Code**

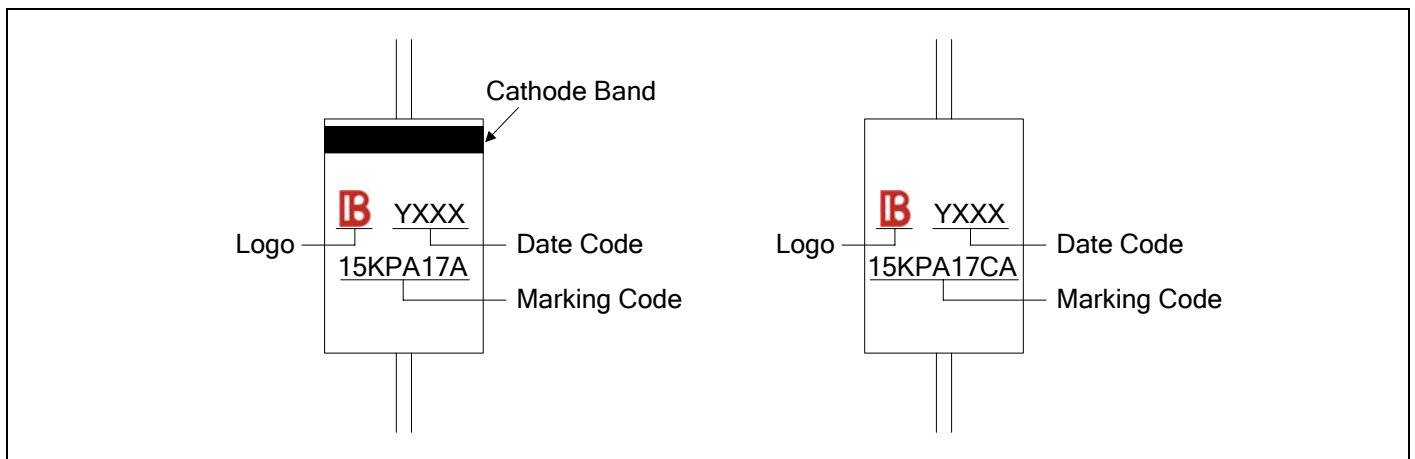

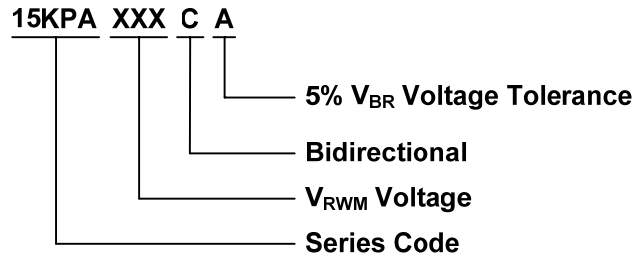

**Packaging**

Tape	Symbol	Dimension (mm)
	A	10.0±0.5
	B	53.0±1.0
	Z	1.2Max.
	T	6.0±0.4
	E	0.8Max.
	L1-L2	1.0Max.
	<b>Box</b>	
	L	250.0±5.0
	W	75.0±5.0
	H	114.0±5.0
	Quantity: 300PCS	
<b>Reel</b>		
	D	330.0±3.0
	D0	16.4±2.0
	D1	86.0±2.0
	W1	76.0±3.0
	Quantity: 800PCS	